

# POWER AND MODULAR SOLUTIONS

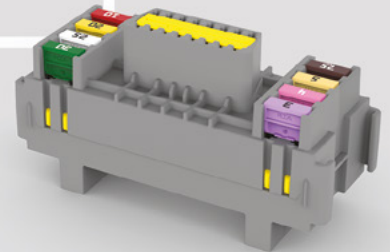
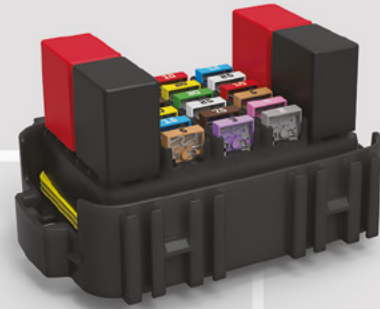

## POWER DISTRIBUTION UNITS

Designated for heavy duty power distribution and main electric services protection, these PDU were developed based on a modular design concept for the utmost versatility.

They have been updated to deliver higher performance and respond to the new demands of these applications. They permit a simplified wiring harness layout in the engine bay to keep harnesses safe from water and dirt.



Read more about MTA power and modular solutions on [www.mta.it/en/electrical-products](http://www.mta.it/en/electrical-products)

## FUSE HOLDERS & MULTIPLE FUSE BLOCK

This new generation of fuse holders can be used stand-alone or can be clipped together to form a multiple fuse block with bus bar.



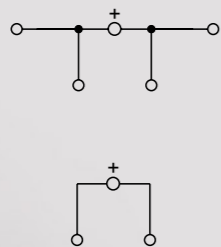

## JUMP START NODE

This product provides a solution for rational safe multi-way electric power distribution. It also features an optional threaded middle pin which serves as a safe power connection to start up and/or charge external electric devices such as batteries or other equipment. This component has a special design that allows it to be adapted to each application.

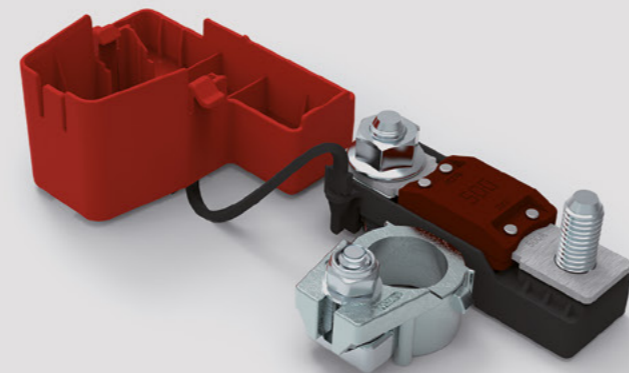

## BATTERY DISTRIBUTION UNIT

Available in 2 different versions, with casted battery terminal in Z axis, right or left side, this battery distribution unit has compact dimensions which make it versatile and easy to be placed. The cover is tethered to the body to ensure it won't be displaced. Quality certified by stringent tests and procedures. Accommodates 1 MegaVal fuse.

## MEGAVAL HOLDERS WATERPROOF

Waterproof MegaVal fuse holders featuring enhanced protection against bumping and tampering. Two versions available: one with cover with gasket to seal the fuse compartment, the other one with "extended" cover to protect the 2 stainless M10 screws too.

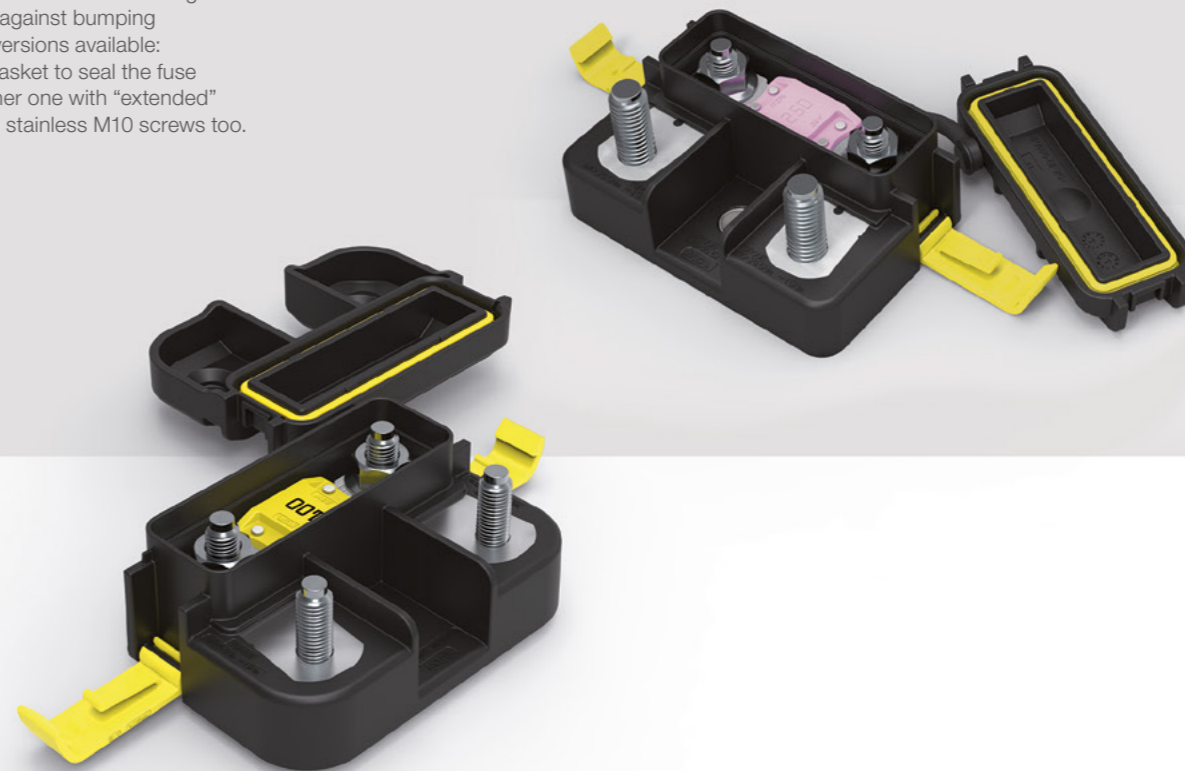

## POWER DISTRIBUTION UNITS

Designed for both light vehicles and heavy-duty applications, these power distribution units can accommodate MidiVal and MegaVal fuses. Their compact shape and multiple fastening points make them versatile and easy to use.



PDU 2M

 WATERPROOF

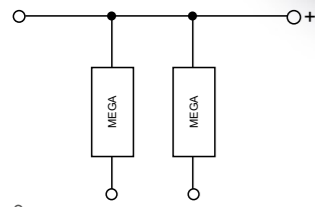

6

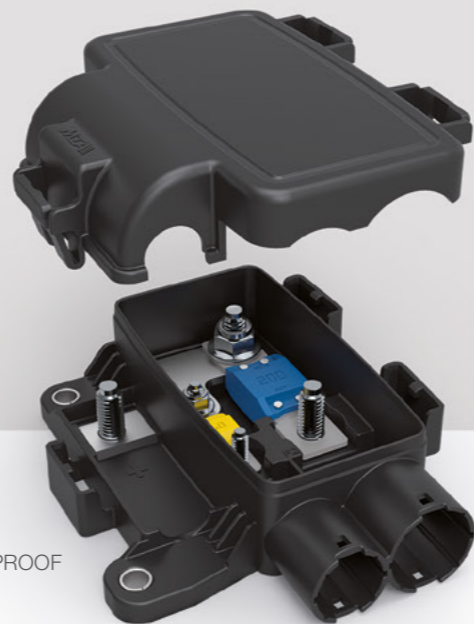

PDU 2

 WATERPROOF

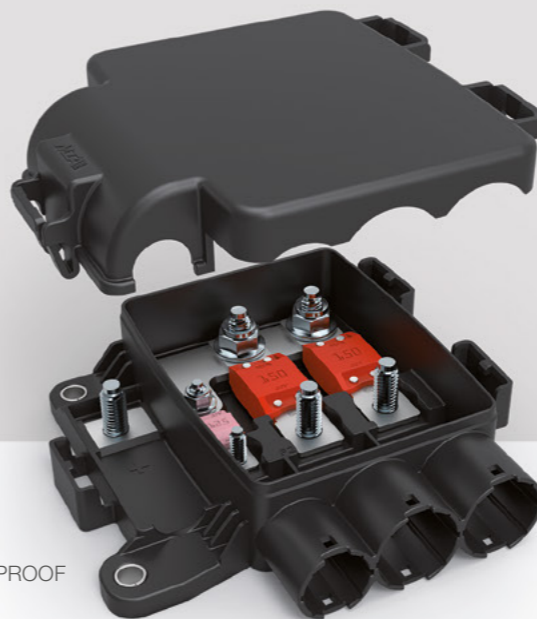
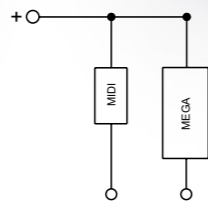

PDU 3

 WATERPROOF

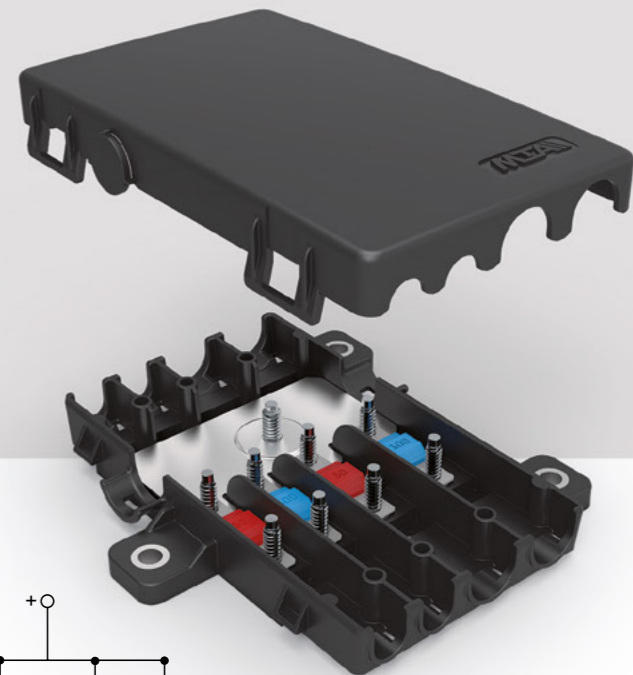
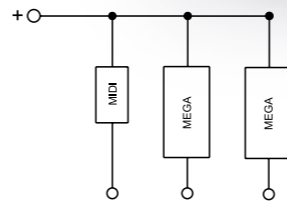

PDU 4

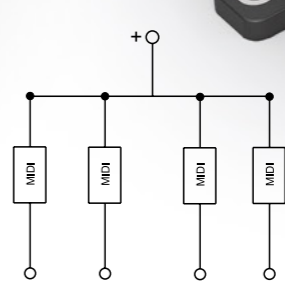

## MEC 25 & MEC 97



WATERPROOF

These configurable Modular Electrical Centers have been developed mainly for agriculture, construction, heavy duty and off-road applications.

### MAIN FEATURES

- Press-fit technology.
- A Gore-Tex vent provides a barrier against water and dust and allows the free circulation of air, avoiding the formation of moisture.
- MEC can be fixed in flat, inclined or vertical position.
- Appropriate latches preload the cover against the seal and close the MEC.
- The cover is tethered to the body to ensure it won't be displaced.
- Anti-vibration system integrated inside the fixing points.

### CUSTOMIZATION LEVELS

There are 4 customization levels Soft, Medium, Medium\* and High, where:  
 ✓ means "customizable component",  
 - means "default component".

	Soft	Medium	Medium*	High
Fuses and relays	✓	✓	✓	✓
Type and number of contents (mask)	-	-	✓	✓
PCB	-	✓	✓	✓
External connections (studs and connectors)	-	-	-	✓



### MEC 25

Accepts 6 MiniVal, 3 MidiVal, and 7 MaxiCompact (+2 spare).

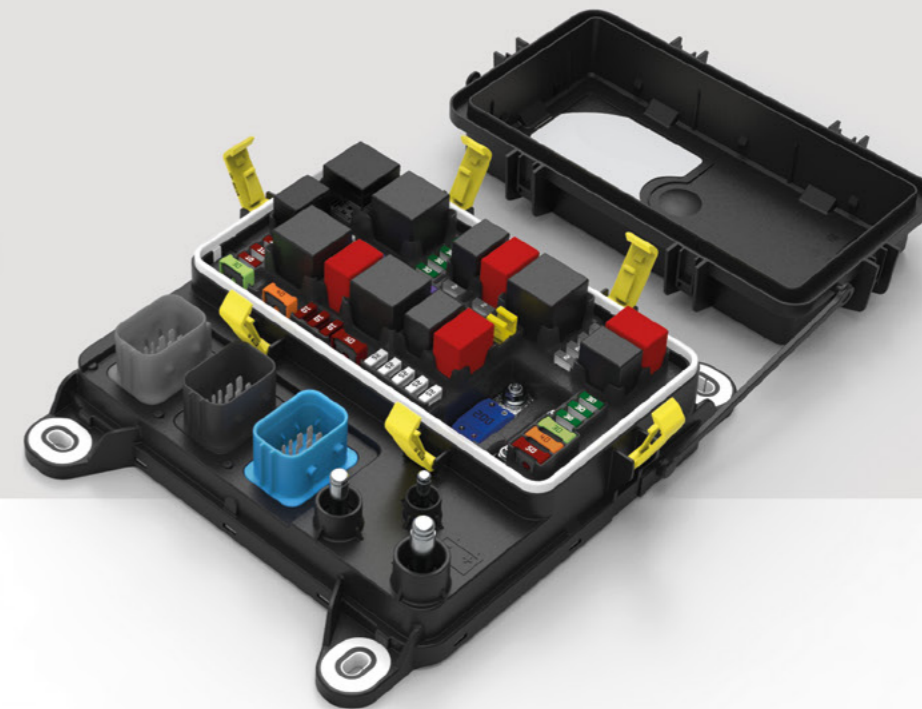

### MEC 97

Accepts 3 MaxiCompact (+3 spare), 34 MiniVal (+3 spare), 1 MegaCompact, 1 MidiVal, 8 Micro relays, 5 Maxi relays.

Optional module to convert CAN bus messages into digital outputs.

## POWER DISTRIBUTION UNITS

### C-MEC 138

This configurable Cabin-Modular Electrical Center has been developed mainly for agriculture, construction, heavy duty and off-road applications.

The C-MEC 138 with PCB made with press-fit, was designed for the cabin and with a high level of customization.

It is ideal for new applications and for those who already use the MTA 5-way frame, with which it is perfectly interchangeable.

#### CUSTOMIZATION LEVELS

There are 3 customization levels Soft, Medium and High, where:

- ✓ means “customizable component”,
- means “default component”.

	Soft	Medium	High
Fuses and relays	✓	✓	✓
Type and number of contents (mask)	–	–	✓
PCB	–	✓	✓
Connectors	–	–	✓

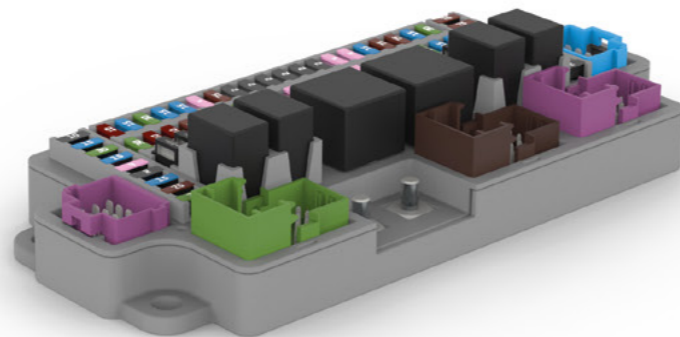

## POWER DISTRIBUTION UNITS

### CONFIGURABLE PDUs

These PDUs offer a high level of flexibility: They can house electronic BDS and different combinations of bussed MidiVal and MegaVal fuses (up to 4 MidiVal and 2 MegaVal). They can also accommodate 5 MiniVal fuses or any fuse and relay holder module in the MTA range. A seal mounted in the cover assures protection from dust and water.

 SPLASH PROOF



#### PDU 6 BDS

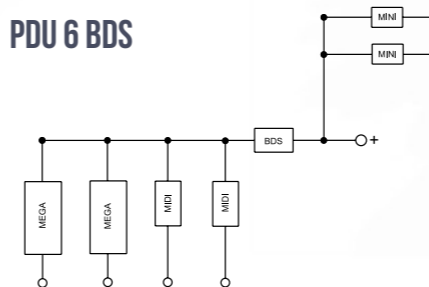

#### PDU 6

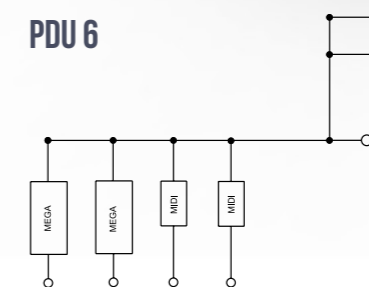

#### PDU 8

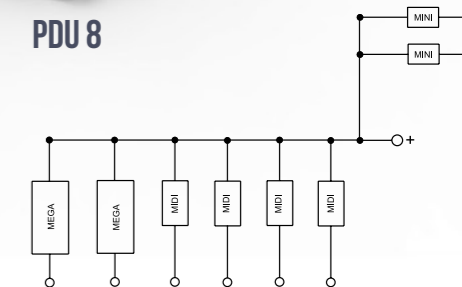

## FRAMES, BRACKETS, COVERS & MODULES

We offer 15 modules and a variety of frames, covers, and brackets to build a wide range of flexible modular solutions for holding fuses, relays, or diodes. All of these products are equipped with secondary locks to guarantee maximum safety and high performance. They are built to resist stress and provide reliable technology.

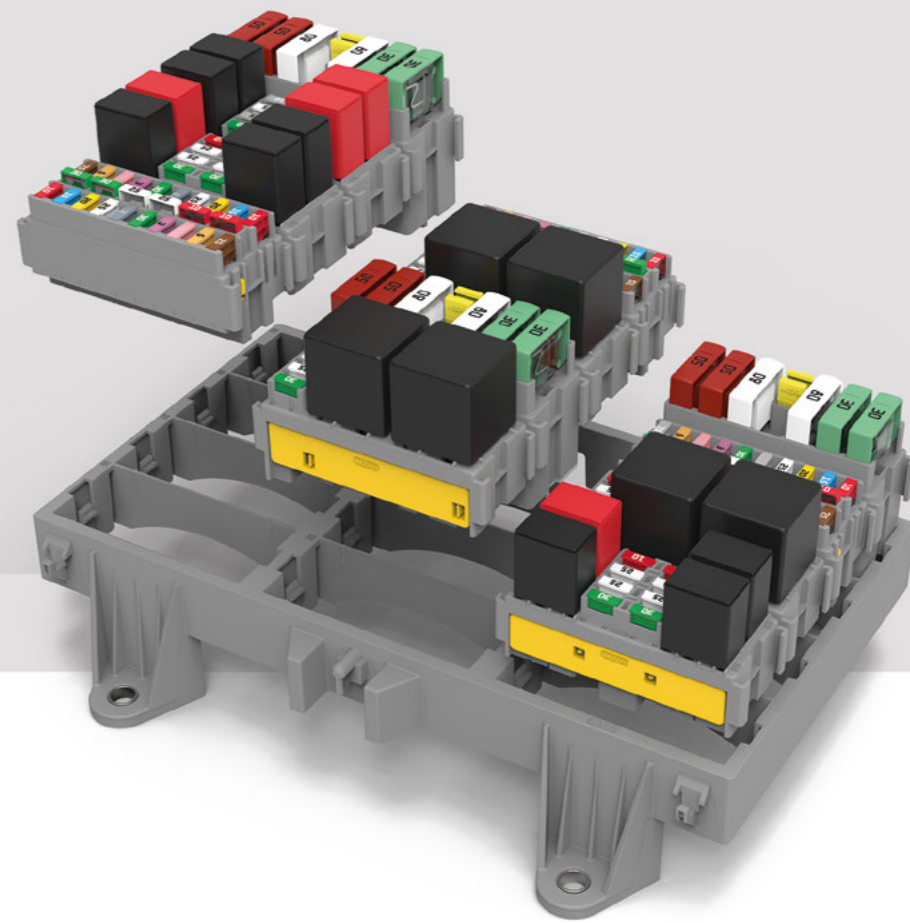
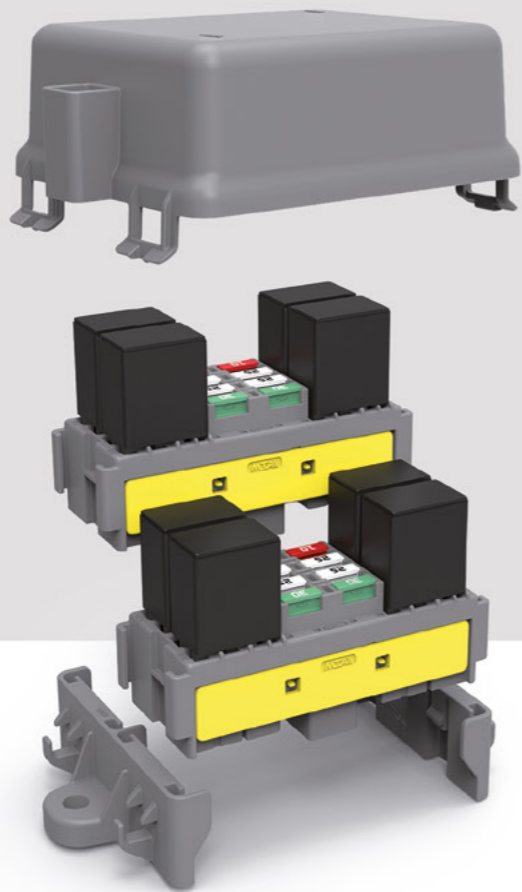

### 0301460

CONTENTS  
26 MiniVal fuses

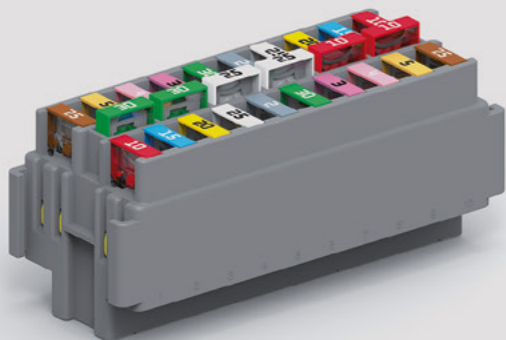

### 0301640

CONTENTS  
20 diodes or  
20 MiniVal fuses

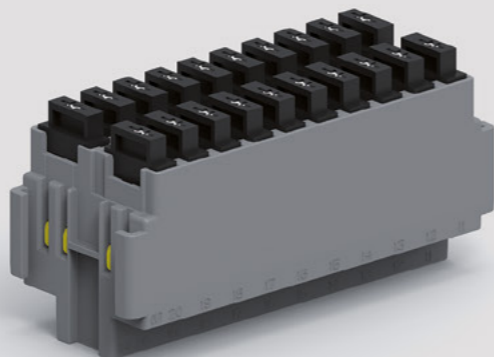

### 0301564

CONTENTS  
8 MiniVal fuses  
4 Micro relays

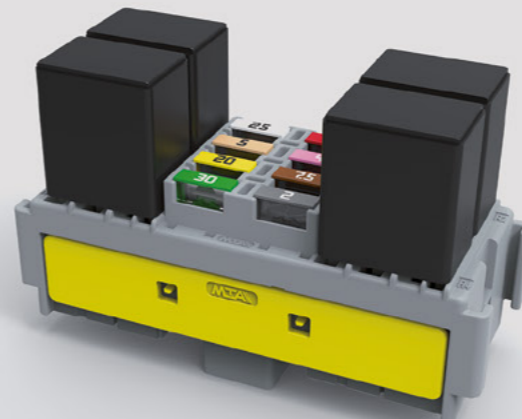

### 0301484

CONTENTS  
6 Micro relays

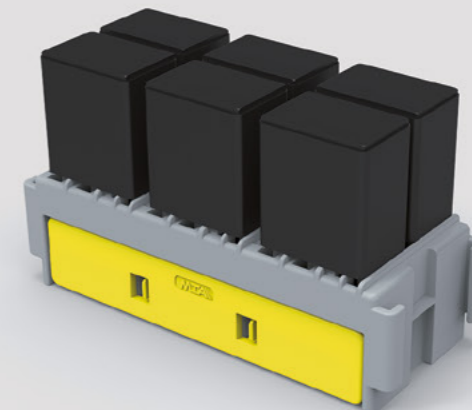



## 0301494

CONTENTS  
1 Maxi relay  
1 Mini relay

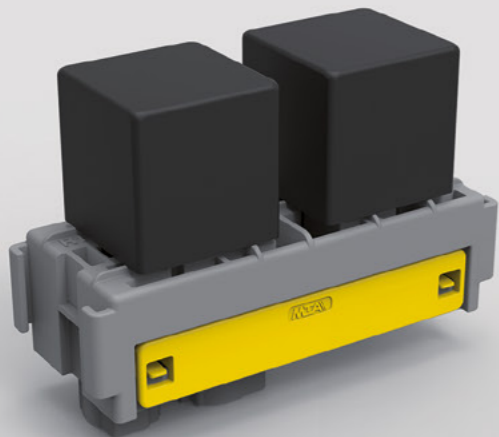

## 0301660

CONTENTS  
2 Maxi relays

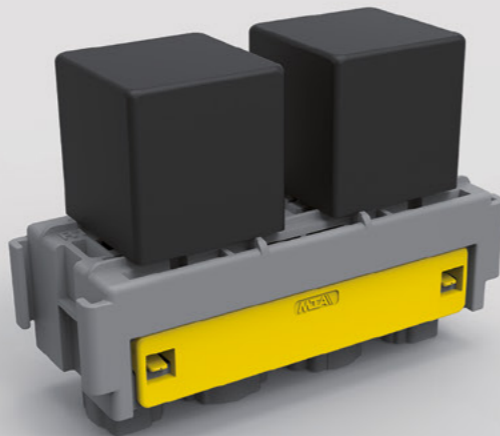

## 0301504

CONTENTS  
4 MiniVal fuses  
2 Mini relays

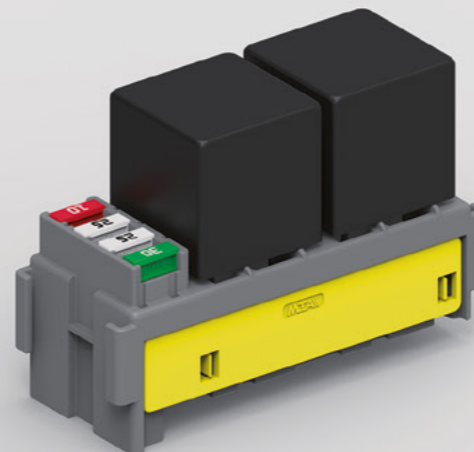

## 0301695

CONTENTS  
3 MaxiCompact fuses  
1 Maxi relay  
2 Micro relays

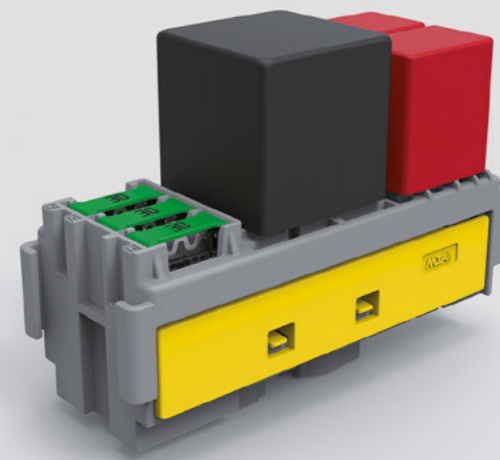

### 0301470

CONTENTS  
6 MaxiVal fuses

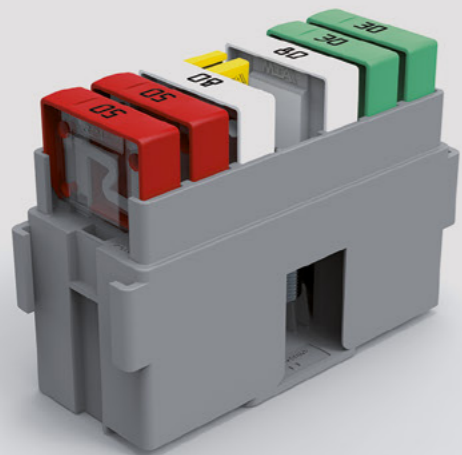

### 0301510

CONTENTS  
10 MiniVal fuses  
1 Maxi relay

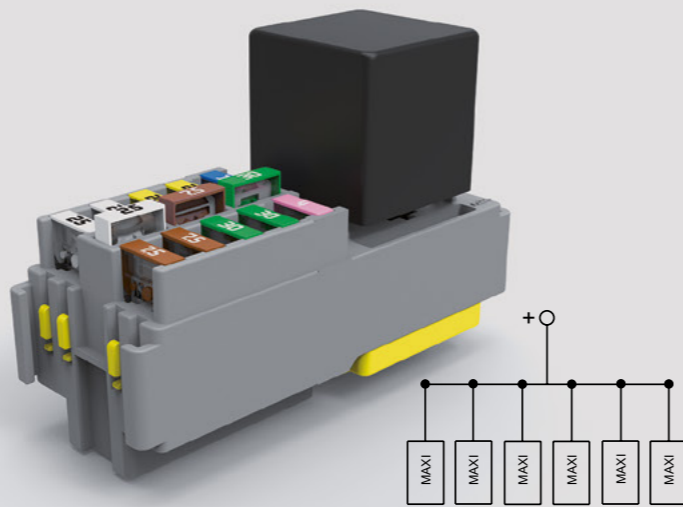

### 0301600

CONTENTS  
3 MaxiVal fuses  
6 UniVal fuses



### 0301690

CONTENTS  
4 MiniVal fuses  
6 type A1 S fuses



## 0301697

CONTENTS  
 5 MiniVal fuses  
 5 MaxiCompact fuses  
 3 M8Compact fuses

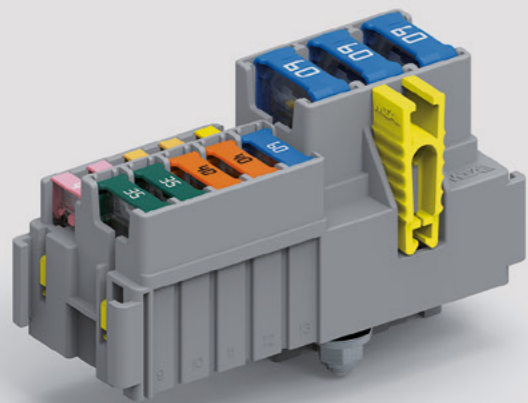

## 0301698

CONTENTS  
 20 MiniVal fuses or  
 20 circuit breakers or  
 20 diodes or  
 6 Micro 280 relays or  
 mixed MiniVal fuses, diodes, circuit breakers

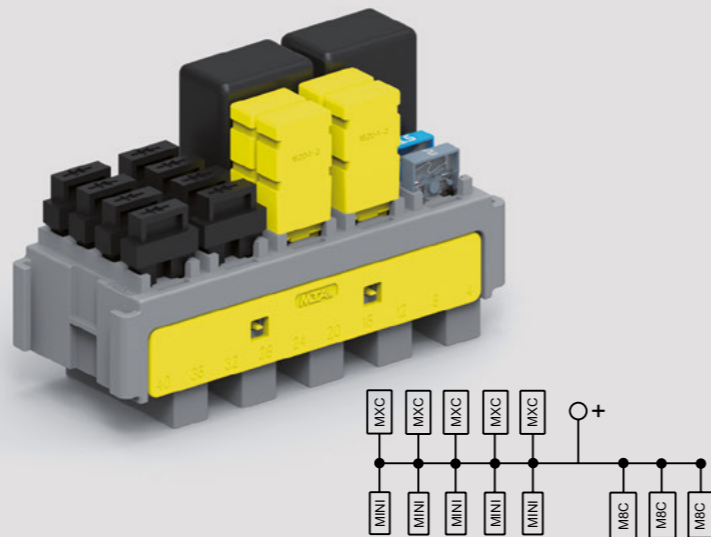

## 0301375

CONTENTS  
 8 MiniVal fuses  
 1 OBD connector

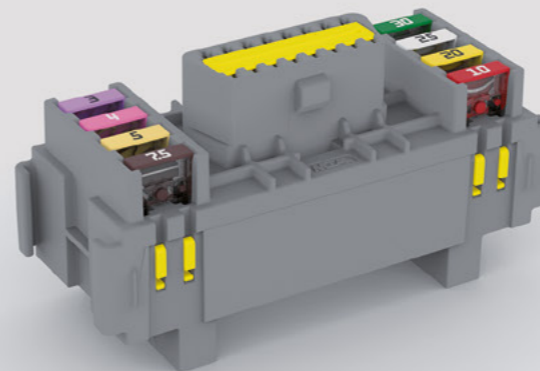

## WATERPROOF MODULES

Vehicles operating around water and mud need advanced environmental protection. Our range of watertight modules has been developed to satisfy this need. All terminals are equipped with a grommet, and a radial silicone seal housed between the module and its cover keeps the modules secured tightly. Modularity is the core philosophy behind these products: all modules can be used interconnected or stand alone and fixed with dedicated mounting brackets. They can all accommodate fuses, relays, or both.



### 0301370

CONTENTS  
30 MiniVal fuses or  
10 Micro 280 relays or  
mixed relays and MiniVal fuses



### 0301491

CONTENTS  
6 MiniVal fuses  
1 MaxiVal fuse  
2 Maxi relays  
1 Micro relay

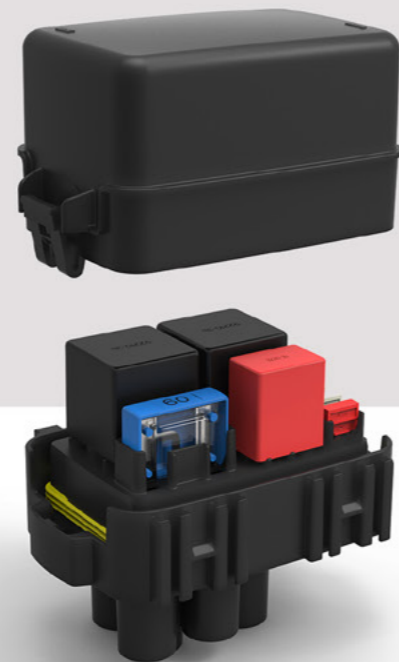

### 0301568

CONTENTS  
18 MiniVal fuses  
4 Micro relays



### 0301373

Same module with integrated  
mounting brackets.

### 0301569

CONTENTS  
6 MiniVal fuses  
1 MaxiVal fuse  
1 Mini relay  
3 Micro relays



### 0301374

Same module with integrated  
mounting brackets.

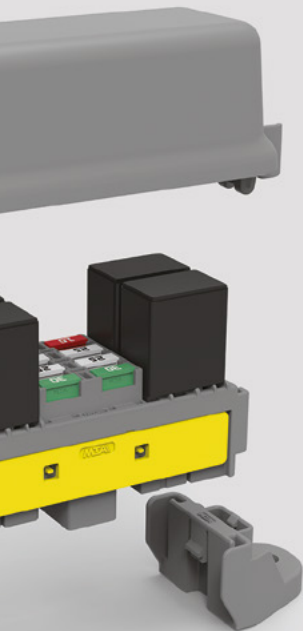

ITALY  
BRAZIL  
POLAND  
SLOVAKIA  
USA  
INDIA  
CHINA  
MEXICO  
MOROCCO

[www.mta.it](http://www.mta.it)

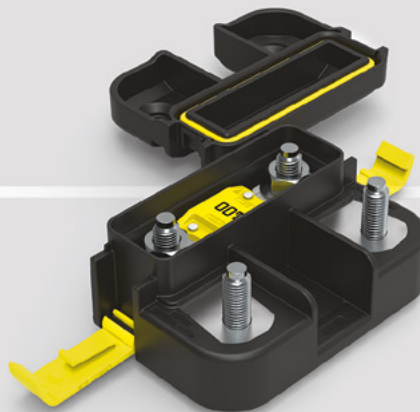

**POWER & MODULAR  
SOLUTIONS**  
Version 1.3  
July 2021

**DISCLAIMER** – Products, information, drawings, specifications and reference numbers (hereafter “contents”) discussed herein are for reference purposes only. All contents herein are provided on an “as is” basis, without warranties of any kind. The contents discussed herein remain the sole and exclusive property of MTA S.p.A. and shall not be copied, translated in whole or in part without MTA S.p.A. prior written consent. No license of any patent, copyright, mask work, trademark or any other intellectual property right is granted under this document, by implication, estoppel or otherwise. Contents may be modified and changed by MTA S.p.A. without any notice. For updates or additional information about MTA products, please contact your nearest MTA office. All brand names, trademarks and registered trademarks belong to their respective owners.